

8mm ROUND SWAGE STANDOFFS

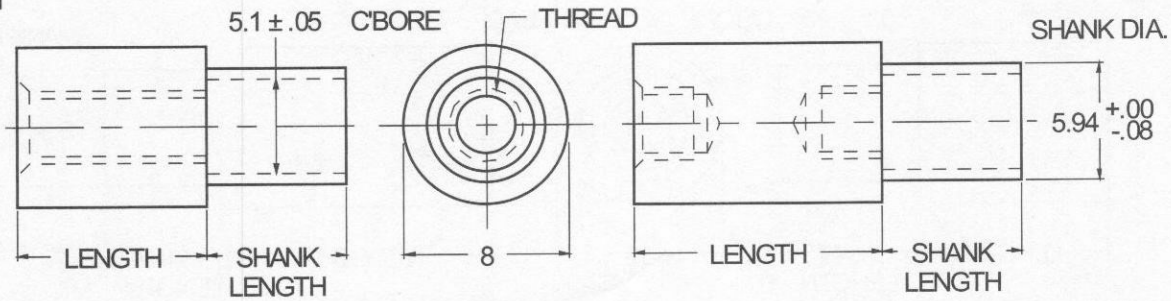

MATERIAL	CODE
ALUMINUM	AL
BRASS	BR
STAINLESS STEEL	SS
STEEL	ST

NOTE: See Page B2 for additional materials and specifications.

THREADSIZE	BASIC PART NO.
M3.5 X 0.6	5117
M4.0 X 0.7	5118

PANEL THICKNESS	SHANK LENGTH ± .08	CODE
.8	1.9	A
1.6	2.7	B
2.4	3.4	C
3.2	4.2	D

LENGTH mm	CODE	LENGTH mm	CODE
3	03.0	27	27.0
4	04.0	29	29.0
5	05.0	30	30.0
6	06.0	32	32.0
8	08.0	33	33.0
10	10.0	35	35.0
11	11.0	37	37.0
12	12.0	38	38.0
13	13.0	40	40.0
14	14.0	41	41.0
16	16.0	44	44.0
19	19.0	45	45.0
20	20.0	48	48.0
22	22.0	51	51.0
25	25.0		

NOTE: For lengths not listed, contact Lyn-Tron, Inc.

PANEL HOLE SIZE
5.99-6.07

SWAGETOOLING		
PUNCH	ANVIL	BODY LGTH.
234	8-1	3mm-5mm
	8-2	6mm-12mm
	8-3	13mm-18mm
	8-4	19mm-51mm

CODE	FINISH	CODE	FINISH
00	Plain — None	33	Black Zinc
01	Passivate MIL-F-14072-E300	34*	Zinc QQ-Z-325, Type II, CL 3 — Clear Chromate
02	Caustic Etch	35	Zinc QQ-Z-325, Type I, CL 3
03	Bright Dip — Brass	36	Zinc QQ-Z-325, Type II, CL 3 — Yellow Chromate
11	Anodize MIL-A-8625C, Type I Chromic Hot Water Seal — Dark Grey	42	Electro Tin MIL-T-10727, Type I (Dull)
12	Anodize MIL-A-8625C, Type II Sulphuric Hot Water Seal — Clear	43	Electro Tin MIL-T-10727 C, Type I (Bright)
13	Anodize MIL-A-8625C, Type II Sulphuric Dichromate Seal — Yellow Green	44	Electro Tin (Solder) MIL-F-14072 M230/M222
14	Anodize MIL-A-8625C — Black	48	Copper / Nickel / Bright Tin
21	Iridite MIL-C-5541 — Clear	50	Black Oxide MIL-C-13924 — Steel
22*	Iridite MIL-C-5541 — Gold #14	51	Black Oxide MIL-F-495 — Brass
31	Cadmium QQ-P-416, CL 2 — Clear Chromate	52	Black Oxide MIL-C-13924 — Stainless Steel
32	Cadmium QQ-P-416, CL 2 — Color Chromate	63	Ductile Nickel
		66	Electroless Nickel
		91	Silver QQ-S-365

*Standard finishes: Zinc (Clear Chromate) on brass material, Iridite (Gold #14) on aluminum material.