

CYLINDRICAL STUD MOUNTS: DOUBLE STUD (MALE/MALE) SERIES (G05-141)

Dimensions & Performance Characteristics

G05-141 CYLINDRICAL STUD MOUNT Dimensional Drawing

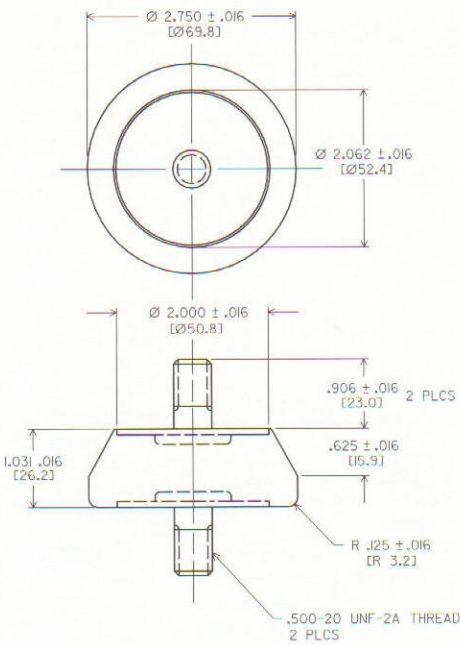

G05-141 Load vs Deflection

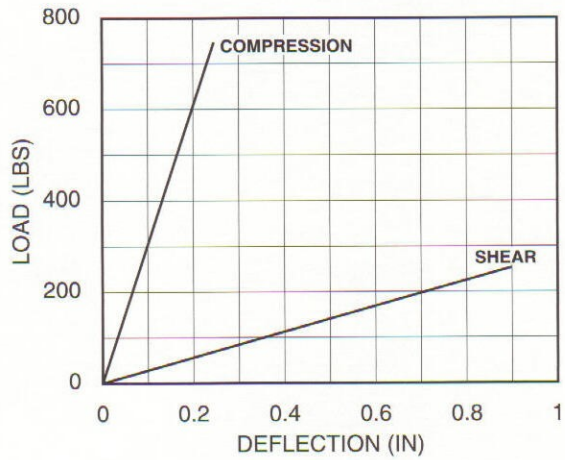

Static Load (lbs.) IN SHEAR	Natural Frequency (Hertz)
70.0	6.0
60.0	7.5
45.0	8.0
35.0	10.0
30.0	12.0
19.0	13.0
17.0	17.0
9.0	20.0
IN COMPRESSION	
260.0	10.0
190.0	12.0
140.0	13.0
90.0	17.0
60.0	20.0
24.0	20.0