

# CYLINDRICAL STUD MOUNTS: DOUBLE STUD (MALE/MALE) SERIES (G05-141)

## Dimensions & Performance Characteristics

### G05-141 CYLINDRICAL STUD MOUNT Dimensional Drawing

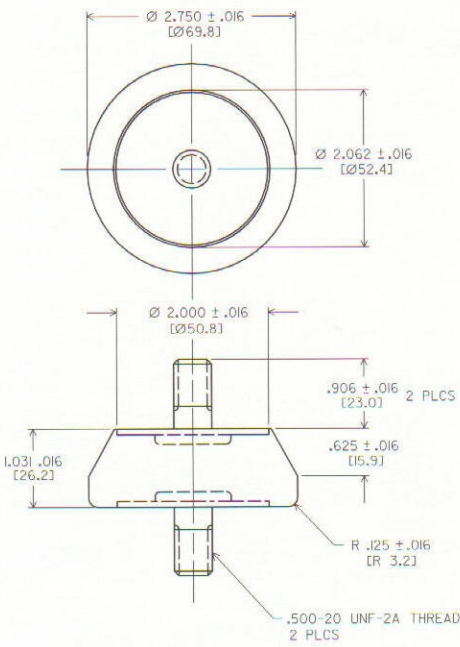

### G05-141 Load vs Deflection

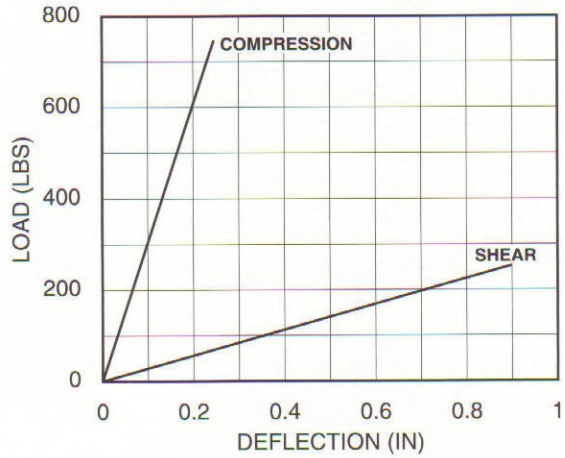

Static Load (lbs.) IN SHEAR	Natural Frequency (Hertz)
70.0	6.0
60.0	7.5
45.0	8.0
35.0	10.0
30.0	12.0
19.0	13.0
17.0	17.0
9.0	20.0
IN COMPRESSION	
260.0	10.0
190.0	12.0
140.0	13.0
90.0	17.0
60.0	20.0
24.0	20.0