

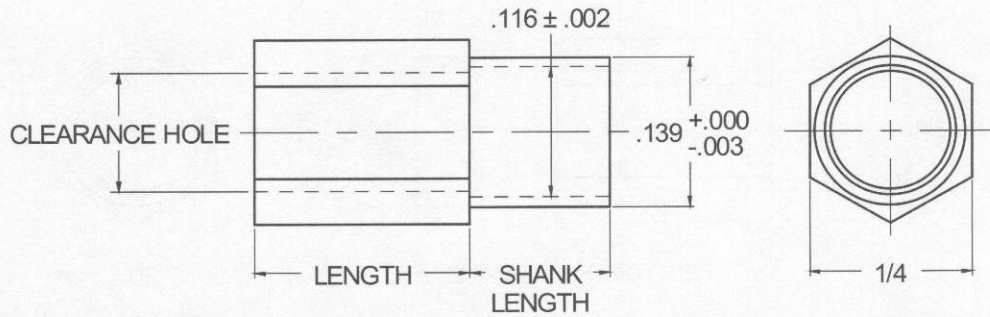

1/4 HEX SWAGE SPACERS .139 Shank Diameter



ORDERING CODE	XX	XXXX	X	—	X.XXX	—	XX
	MATERIAL	BASIC PART NUMBER	SHANK CODE		LENGTH CODE		FINISH

MATERIAL	CODE
ALUMINUM	AL
BRASS	BR
STAINLESS STEEL	SS

NOTE: See Page A4 for additional materials and specifications.

PANEL THICKNESS	SHANK LENGTH ± .003	CODE
1/32	.075	A
1/16	.105	B
3/32	.135	C
1/8	.165	D

NOTE: See Page A5 for additional shank lengths.

LENGTH	CODE
1/8	0.125
3/16	0.187
1/4	0.250
5/16	0.312
3/8	0.375
7/16	0.437
1/2	0.500
9/16	0.562
5/8	0.625
11/16	0.687
3/4	0.750
13/16	0.812
7/8	0.875
15/16	0.937
1"	1.000

CLEARANCEHOLE +.010 / -.000	BASIC PART NO.
.088	6325
.114	6326

PANEL HOLE SIZE
.141 - .144

SWAGETOOLING		
PUNCH	ANVIL	BODYLENGTH
139	290-1	1/8 - 3/16
	290-2	1/4 - 7/16
	290-3	1/2 - 11/16
	290-4	3/4 - 1"

CODE	FINISH	CODE	FINISH
00	Plain — None	33	Black Zinc
01	Passivate MIL-F-14072-E300	34*	Zinc QQ-Z-325, Type II, CL 3 — Clear Chromate
02	Caustic Etch	35	Zinc QQ-Z-325, Type I, CL 3
03	Bright Dip — Brass	36	Zinc QQ-Z-325, Type II, CL 3 — Yellow Chromate
11	Anodize MIL-A-8625C, Type I Chromic Hot Water Seal — Dark Grey	42	Electro Tin MIL-T-10727, Type I (Dull)
12	Anodize MIL-A-8625C, Type II Sulphuric Hot Water Seal — Clear	43	Electro Tin MIL-T-10727 C, Type I (Bright)
13	Anodize MIL-A-8625C, Type II Sulphuric Dichromate Seal — Yellow Green	44	Electro Tin (Solder) MIL-F-14072 M230/M222
14	Anodize MIL-A-8625C — Black	48	Copper / Nickel / Bright Tin
21	Iridite MIL-C-5541 — Clear	50	Black Oxide MIL-C-13924 — Steel
22*	Iridite MIL-C-5541 — Gold #14	51	Black Oxide MIL-F-495 — Brass
31	Cadmium QQ-P-416, CL 2 — Clear Chromate	52	Black Oxide MIL-C-13924 — Stainless Steel
32	Cadmium QQ-P-416, CL 2 — Color Chromate	61	Nickel QQ-N-290 CL 1, Type VI KC
		63	Ductile Nickel
		66	Electroless Nickel
		91	Silver QQ-S-365

*Standard finishes: Zinc (Clear Chromate) on brass material, Iridite (Gold #14) on aluminum material.